

SKIPPER

DL1-Multi

Single Axis Doppler Speed Log System User Manual



Control unit



Electronic unit

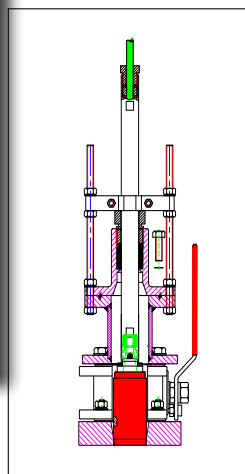

Sensor

SKIPPER Electronics AS
Enebakkeveien 150
P. O. Box 151, Manglerud
0612 Oslo, Norway
www.skipper.no

Telephone: +47 23 30 22 70
Telefax: +47 23 30 22 71
E-mail: support@skipper.no
Co. reg. no: NO-965378847-MVA

Document no: **DM-M005-SA**
Edition: 2013-08-20
Rev: 1.50

**DL1-
MULTI*****SINGLE AXIS DOPPLER SPEED LOG SYSTEM
COMPACT VERSION***

USER MANUAL (ENGLISH)

August 2013

Edition 2013-08-20 sw. 1.50

Weitergabe sowie vervielfältigung dieser unterlage, verwertung und mitteilung ihres Inhaltes nicht gestattet, soweit nicht ausdrücklich zugestanden. Zuwiderhandlungen verpflichten zu schadenersatz.

Toute communication ou reproduction de ce document, toute Exploitation ou communication de ou son contenu sont interdites, sauf autorisation expresse. Tout manquement à cette règle est illicite et expose son auteur au versement de dommages et intérêts.

Copying of this document, and giving it to others and the use or communication of contents thereof, are forbidden without express authority. Offenders are liable to the payment of damages.

Sin nuestra expresa autorización, queda terminantemente prohibida la reproducción total o parcial de este documento, así como su uso indebido y/o su exhibición o comunicación a terceros. De los infractores se exigirá el correspondiente resarcimiento de daños y perjuicios.

SKIPPER

Electronics AS

COMMUNICATING WITH US

If you need more information, support or other assistance from us, do not hesitate to contact us:

SKIPPER Electronics AS
P. O. Box 151, Manglerud
0612 Oslo
Norway

Phone: (+47) 23 30 22 70, Fax: (+47) 23 30 22 71
E-mail: sales@skipper.no

SOFTWARE UPDATES AND TECHNICAL SUPPORT

Find us on the internet: www.skipper.no

YOUR FEEDBACK IS APPRECIATED

If you find errors, misspellings or poorly explained sections in this document, we are happy to receive your feedback at:

support@skipper.no

OVERVIEW

CONTENT OF THE MANUAL

TERMINOLOGY

Terms, units and abbreviations used in this manual.

CHAPTER 1 - INTRODUCTION

This part introduces you to the elements of the DL1-Multi Doppler speed log system.

CHAPTER 2 – RUNTIME OPERATION

Once the system is installed and operational, the user can change the screen to show the data of interest at any particular time. This section explains the basic operation of the system.

CHAPTER 3 – CALIBRATION

Each new installation is unique and the system must be matched to the vessel. Calibration is required to avoid influence of mounting errors and that hydrodynamics of the vessel are compensated for. This chapter explains the procedure in a step by step guide.

CHAPTER 4 – SETTING UP THE DL1-MULTI DOPPLER SPEED LOG SYSTEM

The CD401CU Compact display is a flexible dot matrix LED display designed to display navigation data. It can also be used as a primary sensor display for speed logs showing the speed values produced by the sensor, or as a simple repeater. The Compact speed log with its electronic unit (JB70D1) meets all the requirements of a primary device, both functionally and electrically. This chapter explains how to set up the unit.

CHAPTER 5 – CHECKING OUT YOUR SYSTEM

It is a good idea to verify your systems performance from time to time. This chapter describes how to check interfaces and other issues. In the event of malfunction, this is a good place to start for trouble shooting.

CHAPTER 6 – MAINTENANCE

To keep your system in order, regular maintenance is important. To take advantages of new features and performance enhancements, you may need to update software. This section shows how.

SYSTEM SPECIFICATION

Here you will find data sheet of DL1-Multi Doppler speed log system.

APPENDIX 1 – BACKGROUND INFORMATION

Here you will find more details of how the system works and which factors are important to know when using it.

APPENDIX 2 – MECHANICAL DRAWINGS

A picture is worth more than 1000 words! In addition to the text describing installation, the mechanical drawings are included to allow correct installation.

APPENDIX 3 - SENDING THE SYSTEM FOR REPAIR

In the unfortunate case of a failure that requires a factory repair, the return sequence described, should be followed.

Please observe the instructions regarding warranty and utilization.

TABLE OF CONTENTS

OVERVIEW	4
Content of the manual	4
TERMINOLOGY	8
Terms used in this manual	8
Units	8
Abbreviations	8
CHAPTER 1	10
Introduction of DL1-Multi Doppler speed log system	10
Speed	11
Alarms	11
Distance	11
The control unit	11
Maintenance	11
Diagnostics	11
CHAPTER 2	12
Runtime operation	12
Runtime screens	12
Alarms	12
Adjusting the alarms	12
Runtime diagram	13
CHAPTER 3	14
Calibration	14
The principles	14
Calibration modes	16
Checking the calibration	19
CHAPTER 4	20
Setting up the DL1-Multi Doppler speed log system	20
Principles	20
Run screens	20
Setup screens	20
Activating the runtime screens	21
Configuring of data screens	21
Setup of inputs and outputs	22
Averaging	22
Changing the baud rate	23
Demo mode	23
Menu diagram	24
Setup using the LAN web interface	26

CHAPTER 5	28
Checking out your system	28
Self diagnostics	28
Test points within the system.....	31
Status LED diagram	33
CHAPTER 6	33
Maintenance.....	33
Routine maintenance	33
Checking your version.....	33
Software upgrade	34
Master reset (factory default settings).....	34
SYSTEM SPECIFICATION	35
APPENDIX 1	37
Background information	37
APPENDIX 2	38
Mechanical drawings.....	38
1) Exploded view	38
2) System overview diagram.....	40
APPENDIX 3	42
Sending the system for repair	42
Warranty and Utilization	42
Installation/commisioning of the EML224 Compact	43

TERMINOLOGY

TERMS USED IN THIS MANUAL

UNITS

Unless otherwise stated, all values shown on the display are as follows:

Distance	Nautical miles (nm)
Speed	Nautical miles per hour (kn)
Pulse indication	Pulses per nautical mile (p/nm)
Temperature	Degrees Celsius (°C)

ABBREVIATIONS

In addition, the following symbols are used on the runtime screens:

Tp	Daily trip (in nm)
TL	Total measured distance travelled
°	Degrees centigrade
STW	Speed through water
TRIP	Text for trip/total
SOG	Speed over ground
TEMP °	Text for TEMPerature

In menu/setup screens, the following abbreviations are used:

STWWL	Speed through water – water track – longitudinal value
STWWT	Speed through water – water track – transversal value
SOGBL	Speed over ground – bottom track – longitudinal value
SOGBT	Speed over ground – bottom track – transversal value
SOGBA	Speed over ground – bottom track – aft value
SPDHI	High speed alarm
SPDLO	Low speed alarm
SENSR	System / sensor alarm
PULSE	Pulse settings
OFS °	Angular offset in degrees (°)
R	Real resultant speed at a specific point (kn)
M	Measured resultant speed at a specific point (kn)

C_{rs}	Calibrated resultant speed
M_{rs}	Instantaneous uncalibrated measured resultant speed
DIAG	Diagnostics menu

Outgoing NMEA messages follows:

VMVLW	\$VMVLW,...., Trip and total
VMMTW	\$VMMTW,...., Water temperature
VMVHW	\$VMVHW,...., Relative speed through water
VMVBW	\$VMVBW,...., Multiple speed
VMXDR	\$VMXDR,...., Speed direction
VMALR	\$VMALR,...., Cause

Other terms:

LAN	Local Area Network
PoE	Power over Ethernet
UDP	User Datagram Protocol - A method of transmitting messages on network.

CHAPTER 1

INTRODUCTION OF DL1-MULTI DOPPLER SPEED LOG SYSTEM

The DL1-Multi Doppler speed log system works by the Doppler principle. This principle is that a sound bouncing off a moving object will change in frequency. This principle can be utilized by making a narrow beam of sound and analyzing the frequency of the returning sound. This frequency change is proportional to the relative speed of the sound projector and reflecting object.

On a vessel, a transducer is positioned pointing slightly in one direction and the reflected sound comes from particles in the water or the bottom. The frequency of these echoes is translated to speed.

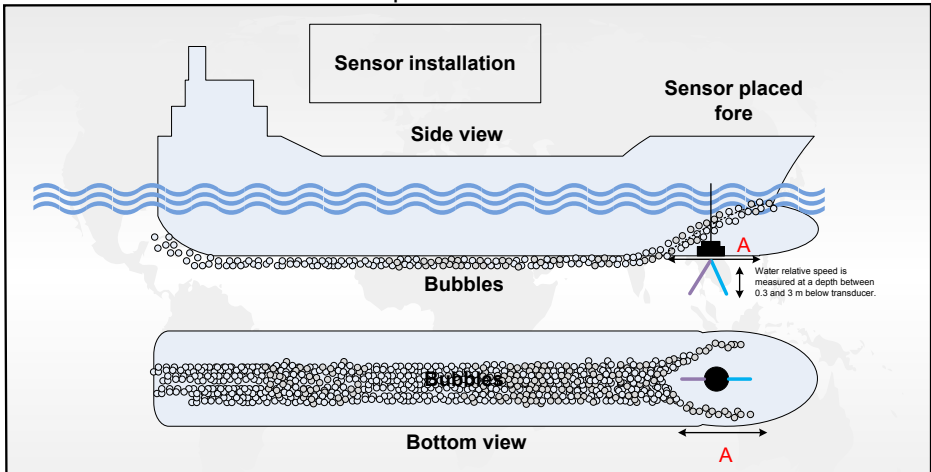

The DL1-Multi system has two sound beams in directions angled out from the vertical to get good speed definition. These two beams are angled so that the measurement axis (longitudinal) can be detected. It sends from the two beams at the same time but at slightly different frequencies so that the beams do not mix. The transducers are moulded into the same sensor head together with the amplifiers and detection circuitry (transceiver).

The sensor also contains temperature sensors and tilt sensors to **allow** compensation of the data. The transceiver contains a small computer which processes the data and signals and converts them to speeds. This data is sent to the electronic unit (JB70D1-XX) where it is formatted and presented on the control unit and web page, and as data in formats to be integrated into the vessels navigation and presentation systems such as repeaters and conning.

SPEED

The screen presents speed through water (STW) used for the autopilot, radar and logged on the voyage data recorder (VDR). The speed data is also used for setting limits on the rudder and stabilizer wings.

ALARMS

Alarms can be set on the speed, and these are commonly used to warn the crew if the vessel is in danger of losing rudder steerage, or if the vessel is going over its recommended speeds.

DISTANCE

In addition, the system shows distance travelled through water and has a resettable daily trip counter. This information is used for service intervals and navigation. Extra information is available regarding the sea temperature.

THE CONTROL UNIT

The user can operate the system via a simple to use touch screen or using a web page on the conning unit. The displays are intuitive and have a menu system, but also allows the user to click on the screen to adjust the relevant parameters. Full setup, calibration and diagnostics are available from the screens. Calibration is performed by a simple two leg sailing procedure, and once set, should not need repeating unless the sensor is moved or replaced.

MAINTENANCE

The system is low maintenance. After initial setup and calibration, the system requires no attention except to change alarm parameters if required. The sensor is exposed to the water and over time some growth may appear. This can be carefully removed when possible, and is normally not a problem except if the vessel is still for longer periods of time (weeks) in warm waters. The effect of this growth is usually seen as the range of the bottom track being reduced.

DIAGNOSTICS

The system has comprehensive built in test (BIT) that can be used to analyse the performance of the equipment and give a warning if the data is not within specification. It also has inbuilt redundancy in some areas, such that even if a failure occurs, it can still give some data. Due to the systems LAN network point, it is possible to set up the system for remote diagnostics and upgrade using network. In time this will help reduce service visits and increase the probability of first time fix.

CHAPTER 2

RUNTIME OPERATION

RUNTIME SCREENS

The control unit starts up in run mode. By pressing the MENU button, the preset user screens can be selected. (See [“Menu diagram” on page 24](#)). Some of the menu screens (i.e alarms) are also available in the run mode. The control unit can be dimmed in any of the run screens using the up (↑) and down (↓) buttons. If trip/total are selected as a displayed parameter, they can be reset by pressing and holding the SET button on the trip screen.



ALARMS

The DL1-Multi Doppler speed log system contains three auxiliary outputs and one auxiliary input. These are defined on the web page, but as default they are set to be function alarm, alarm reset, power failure alarm and speed pulse output. The system can also use NMEA ALR alarm message in parallel or instead of the hardware alarms.

- **Speed high** and **speed low** alert the user when the vessel exceeds the speed limits. (NMEA and/or alarm relay output).
- **Sensor alarm** is a system error alarm that activates if a serious system error occurs either in the sensor or communication to the display. (NMEA and/or alarm relay output).
- **Fitness alarm** is a digital output, which if activated, sends a pulse each time a button is pressed on the display.
- **Power failure alarm.** If fitness alarm is deactivated, the output becomes a **power failure alarm** which indicates a power failure in the system. The output will show a high voltage at all times unless if there is a power failure.

ADJUSTING THE ALARMS

When operating as a primary source, the control unit can be made to give an alarm in some conditions. These can be adjusted in the alarms menu page. Values are changed with up (↑) and down (↓) buttons. The different alarm types can be selected from the menu, or by pressing SET to move to the next alarm. Alarm screens can be made available from the runtime screens as described in ‘Activating the runtime screens’ or are otherwise available from the menus.



RUNTIME DIAGRAM

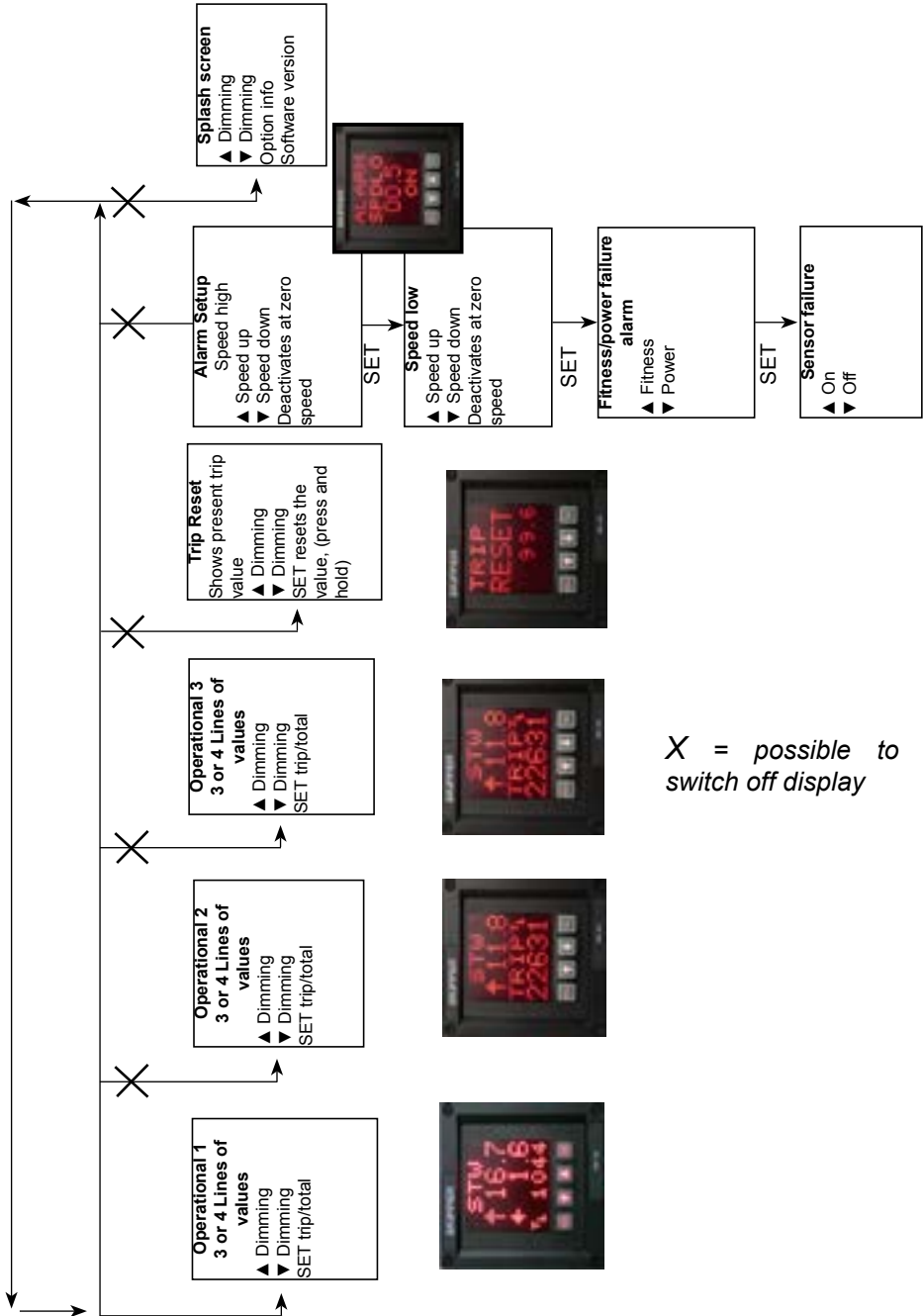

CHAPTER 3

CALIBRATION

THE PRINCIPLES

Calibration of a speed log involves correction the mounting angle of the sensor (heading offset) and the speed error, at various speeds. If the vessel has a laminar water flow near the sensor, a single calibration point will be sufficient. If the flow changes with speed, (due to the friction of the hull, or nearby constructions) then extra calibration points will be required. The sensor is mounted on a pole that can be turned to adjust the angle. This may result in a small angular error.

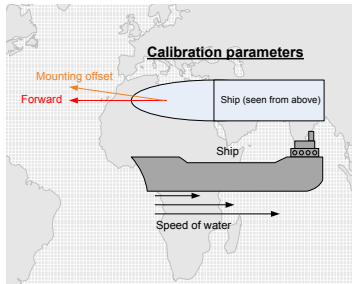
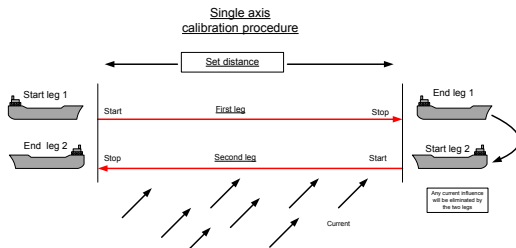

Figure 3.0

This can be calibrated away in the dual axis version, but not in a single axis version, where the sensor must be physically rotated (in the sea valve version). This should be done before the main calibration procedure is performed.

Full calibration is designed to ignore water current effects. The procedure requires the vessel to sail a fixed length track, at a constant speed. To remove the current and wind effects, the same track should then be sailed in the opposite direction. The average of these tracks will be used to calculate the speed difference between the real speed (measured using the actual distance and the time it took), and the measured speed (using distance from the sensor and the time it took). This procedure must be performed at least once, and then other speeds checked with the GPS.

Figure 3.1



If necessary, the procedure should be repeated at different speeds. SKIPPER recommend that calibration is performed at a low speed and a high speed. If the user is not able to turn the vessel and is sure there is no current, the calibration procedure can be stopped after the first leg and saved as a calibration point. This will give values that are correct for that particular condition. (If current is present, the speed through water will contain an error).

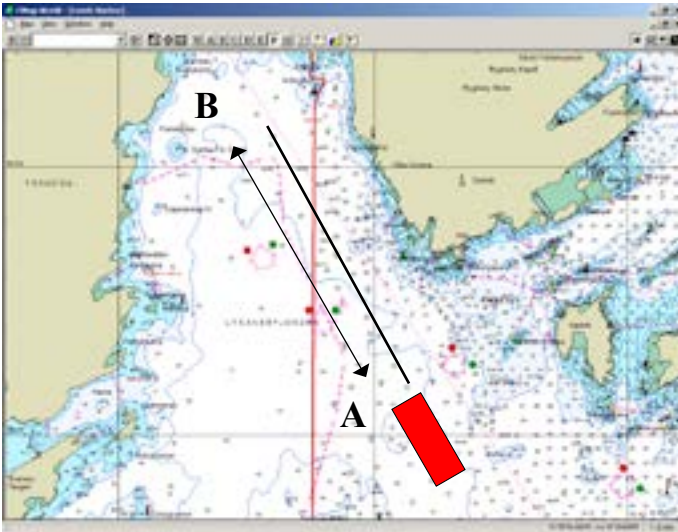

Figure 3.2
Shows plotting a calibration path on the chart.

The leg should take at least 5 minutes to sail (distance can be shorter when sailing slowly).

Reducing Heading errors. Sea valves can be manually adjusted to ensure the sensor is correctly aligned. To minimize the offset, the sensor should be mounted pointing ahead. Error in this factor will result in difficulties in speed calibration

- **Tank mountings** have ahead marks on both the tank and the sensor insert.
- **Sea valves** have either a mark on the top flange or a flat mark on the port side of the pole which, when a flat object is placed against this, will point fore/aft (Figure 3.3).

Figure 3.3

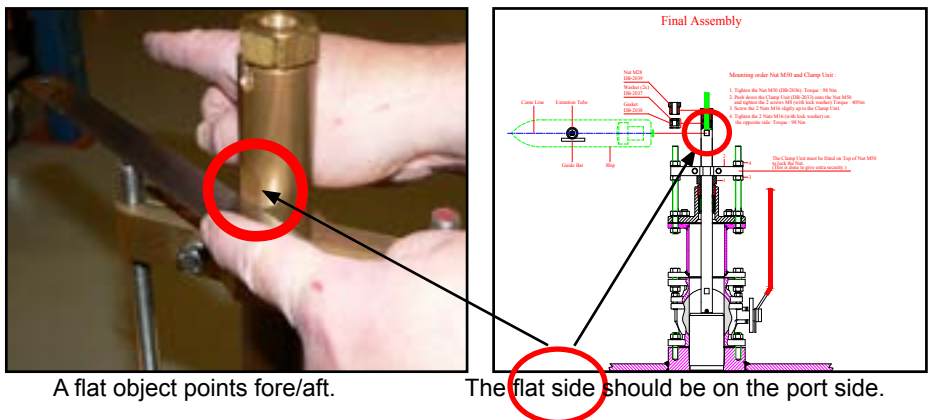

A flat object points fore/aft.

The flat side should be on the port side.

CALIBRATION MODES

The control unit has two modes of calibration:

1. Manual (MANUL).
2. Semi-automatic (AUTO).



Manual mode

The calibration – (MANUL) menu will allow the user to adjust the heading offset, and the speed calibrations individually. Up (↑) and down (↓) adjust the highlighted parameter. SET moves to the next parameter. The data showing the result of the change will be displayed dimmed on the same screen (offset or speed). On the 3rd press, the lower value will change from measured or raw resultant value (Mrs) to calibrated resultant (Crs) to allow the user to check the result of the change.



Procedure

When entering the manual mode, you will be presented with the first speed calibration point.

Pressing SET moves you to the next speed calibration. Enter the real (R) speed and measured (M) speed, (the measured speed can be seen on the bottom line). The calibrated value can be checked by pressing SET one more time. Repeat this process at as many different speeds as necessary. (Up to 10 points, but one or two are usually sufficient).

Hint: Pressing down (↓) and SET together will change the current selected value to the resultant value, or to zero, saving time when adjusting.

Using the Web page

Connect a LAN cable to the JB70D1, go to the web page as defined on the unit (default <http://239.192.1.XX>, Where XX is the last 2 digits of the serial number) and go to the web tab. From there you can select auto calibration, manual calibration or peripheral calibration (temp and tilt). Select manual mode, or GPS mode, then follow the onscreen instructions. Ensure that there is only one column on the calibration table for each speed (+/- ca. 2 knots)

SKIPPER

JB70D1-XX
Electronic unit for DL1

[Home](#) / [System Calibration](#) / [CGM1/CG2 Calibration](#) / [Calibration](#) / [Names / Displays](#) / [Maintenance](#) / [Help](#)

Calibration menu

[Calibration overview](#)

[GPS Speed calibration](#)

[Auto Speed calibration](#)

[Manual Speed calibration](#)

[Temperature calibration](#)

Manual Speed calibration

Calibration point	1	2	3	4	5	6	7	8	9	10	Save / Cancel
Real	0.00	0.00	0.00	0.00	0.00	0.00	0.00	0.00	0.00	0.00	
Measured	0.00	0.00	0.00	0.00	0.00	0.00	0.00	0.00	0.00	0.00	Cancel

Call in an area with no current in the wind and calm seas, in a straight course with heading and COG the same. When a speed signal is stable and trustworthy, call for at least 1 minute read off the GPS. Speed over ground value and enter it in the table with the measured value below.

Current speed	Real (calibrated) speed	0.34 knots ---	Real (calibrated) speed is based on Measured (raw) speed using current calibration table
	Measured (raw) speed	0.34 knots ---	

Alternatively, by using GPS (if connected) the real speed can be taken directly from there.

SKIPPER

JB70D1-XX
Electronic unit for DL1

[Home](#) / [System Calibration](#) / [CGM1/CG2 Calibration](#) / [Calibration](#) / [Names / Displays](#) / [Maintenance](#) / [Help](#)

Calibration menu

[Calibration overview](#)

[GPS Speed calibration](#)

[Auto Speed calibration](#)

[Manual Speed calibration](#)

[Temperature calibration](#)

GPS Speed calibration

Speed input	$\$-VTC_XX_A_4TM-CG-CF-$ <small>(X = 0 = Real (raw) speed in knots)</small>	1.00 knots ---	Save / Cancel
	$\$-VDR_XX_A_7M-CG-CF-$ <small>(X = 1 = Logarithmic speed in knots)</small>	5.00 knots ---	Save / Cancel

Calibration point	1	2	3	4	5	6	7	8	9	10	Save GPS calibration [...]
Real	0.00	0.00	0.00	0.00	0.00	0.00	0.00	0.00	0.00	0.00	
Measured	0.00	0.00	0.00	0.00	0.00	0.00	0.00	0.00	0.00	0.00	

Call in an area with no current in the wind and calm seas, in a straight course with heading and COG the same. When a speed signal is stable and trustworthy, call for at least 1 minute and press the User buttons for VTC and VDR.

Current speed	Real (calibrated) speed	0.34 knots ---	Real (calibrated) speed is based on Measured (raw) speed using current calibration table
	Measured (raw) speed	0.34 knots ---	

Semi-automatic mode

The calibration – AUTO menu will take the user step by step through the calibration menu. The user may follow the steps presented on screen. First drawing a line on the chart system, as shown in figure 3.1 and 3.2.

The line should be sailed at constant stable speed and the line should represent at least 5 minutes of sailing at the current speed.

- **Leg length setting.** (Adjust the length to match the line drawn on the chart).
- **Start first leg.** (The vessel crosses point A at the calibration speed, towards point B).
- **Stop first leg.** (The vessel reaches point B on the chart and turns to sail the line in the other direction).
- **Save first leg.** (If the presented speeds look correct, save the leg and continue).
- **Second leg (option).** (If you do not have the possibility to turn the vessel, you can use the first leg data directly. If the first leg data is of poor quality, you may not be given the option to continue).
- **Start second leg.** (The vessel crosses point B sailing towards point A, sailing at the same speed as leg 1).
- **Stop second leg.** (Press as the vessel passes point B).
- **Calibration result and save option.** (The user can decide to accept or reject this calibration, and in which memory position to save it).



Note: The user should press the start and stop based on position on the chart, and not sailed distance on the unit.

The user may decide which of the 10 calibration points the calibration will be saved in. The screen will display the first available position on the table, or overwrite from zero upwards.

Calibration should occur or be checked whenever the sensor is moved, or a new sensor is mounted. If there is growth on the sensor over time, the speed may be reduced slightly. The sensor should be cleaned and then re-calibrated.

Note: If a new sensor is mounted, the calibration in the control unit may be useable. However, it should be checked.

Calibration using the web page.

Procedure for auto calibration using the web page is the same, however the web gives a better oversight. Enter the leg length and press start, etc. as the vessel sails the required legs.

SKIPPER JB70D1-XX Electronic unit for DL1

Home | System Calibration | CAN/CDC Configuration | Calibration | Alerts | Datastream | Maintenance | Help

Calibration menu

- Calibration overview
- GPS Speed calibration
- Auto Speed calibration**
- Manual Speed calibration
- Temperature calibration

Auto Speed calibration

Actual distance to sail: 0.000 Nautical miles Type in distance to sail

Calibration point: 1 2 3 4 5 6 7 8 9 10

Real:	0.00	0.00	0.00	0.00	0.00	0.00	0.00	0.00	0.00	0.00
Measured:	0.00	0.00	0.00	0.00	0.00	0.00	0.00	0.00	0.00	0.00

For a line of known distance on the ship's chart in an area with little wind and low, stable current. Enter the length of the plotted line in Actual distance. Sail the line at a stable speed (only sailing the back, not at a fixed heading). Press start and stop when the vessel crosses the ends of the line. Turn and repeat in the opposite direction at the same speed. This calibration technique is the most accurate.

Measured Speed distance: 0.00 Nautical miles

Current speed:	Real (calibrated) speed:	0.34 knots	Real (calibrated) speed is based on Measured (raw) speed using current calibration table.
	Measured (raw) speed:	0.34 knots	

CHECKING THE CALIBRATION

To check that the calibration points are not too far from the ideal linearity, the Calibration – GRAPH menu will plot the calibration points on the screen. The user may use up (↑) and down (↓) to select a calibration point and then adjust that value by pressing SET on the relevant point. The MENU button will return you to the GRAPH menu again.



CHAPTER 4

SETTING UP THE DL1-MULTI DOPPLER SPEED LOG SYSTEM

PRINCIPLES

The control unit is a flexible dot matrix LED display designed to display navigation data. The control unit can be user programmed to show most kinds of numerical data, from NMEA messages or self generated. It can also be used as a primary sensor display for speed logs showing the speed values produced by the sensor, or as a simple repeater. The control unit with its electronic unit (JB70D1) meets all the requirements of a primary device, both functionally and electrically. On its own, it meets the requirements as a repeater.

The control unit has three user definable alphanumeric displays, each allowing up to 4 parameters to be displayed. When the unit is used as a primary device, some of these screens will be fixed. In addition to on screen setup, the DL1-Multi system has a LAN interface, enabling the user to perform all the setup actions using a simple web page.

RUN SCREENS

The unit starts up in run mode. By pressing MENU button, the preset user screens can be selected. Some of the menu screens (i.e alarms) are also available in the run mode. The unit can be dimmed in any of the run screens using the up (↑) and down (↓) buttons. If trip/total are selected as a displayed parameter, they can be toggled using the SET button.

SETUP SCREENS

To change the setup of the control unit, the user must simultaneously press MENU and SET. This will give access to a menu system allowing the user to scroll up and down the sub-menus and functions using up (↑), down (↓) and SET to select. To move to the previous menu, the MENU button must be pressed. The middle underlined line is the selected line, the other lines are dimmed.



The menu structure is shown in the diagrams on [“Menu diagram” on page 24](#). The menus are product dependant, only the relevant menus are accessible. However, some menus are always available.

ACTIVATING THE RUNTIME SCREENS

The system has three user definable screens. Screen one may be locked in some configurations. In addition, the user can make the most common setup screens available. The screen menu (SCRN) allows the user to configure and choose which runtime screens to be included in normal operation. Up (↑) and down (↓) buttons will scroll to the available screens. By using the SET button, the user can control each individual screen to ON or OFF. Screens set to ON are available to be displayed by pressing the MENU button. Screens set to OFF will not be displayed.



CONFIGURING OF DATA SCREENS

The three user programmable screens can be set up using the configuration (CONFIG) menu. This submenu allows the user to select one of the three displays. On entering the CONFIG screen, the user can change the data type to be displayed in each of the four screen positions. Up (↑) and down (↓) will change the data type, SET will move to the next screen position. The screen layout will depend on the selected data type. Up to four lines of text and data can be displayed on each screen. Placing TXT in the bottom 4th line or 3rd and 4th line will cause the data to spread out showing fewer data points. The system will not allow you to mix speed data from different sources on the same screen. Having two TXT lines after each other will also rearrange the positioning.

Note: The system needs one screen which indicates just the primary data. This screen is fixed and cannot be adjusted.



The non-active parameters will continue showing the dimmed title data, when not selected.

Example:

Configuration screen

Runtime screen

Configuration screen

Runtime screen



=



=



SETUP OF INPUTS AND OUTPUTS

The system will allow many NMEA formats to be displayed:

VMVBW	Speed long, trans, forward water speed
VMMTW	Temperature (water)
VMVLW	Trip/total (distance sailed)
VMVHW	Speed through water (resultant)
VMALR	Alarm output
VMXDR	Vessel (sensor) direction (only when running in backwards mode)

The system will automatically update recognized formats. If the user wishes to output NMEA, the user can select the NMEA sub menu in the SETUP menu and move to the different formats using the up (↑) and down (↓) buttons. Each format can be activated/deactivated using the SET button.



AVERAGING

Each system type has some filters to ensure stable and correct data. The averaging filter takes a number of measurement pulses and makes a rolling average of these values. The longer the averaging, the more stable the data will be, however, the slower the system will respond to changes. The control unit have a minimum value of 10 seconds. If the system seems unstable at times, increasing the average time will reduce the fluctuations. However, the filtering is time based and as it increases, the response time of the system will decrease.



CHANGING THE BAUD RATE

The NMEA 0183 (IEC61162-1) standard is 4800 baud. Some vessels run with higher baud rates. 4800, 9600, 19200, 38400, 57600 and 115200 baud rates can be selected in the baud page of the setup menu. This page contains two sub menus, one for the sensor and one for the NMEA port. It is recommended that the sensor is kept to 4800 baud, as this speed is robust with longer cables. To switch between sub pages, the SET button is used. The baud rates become active when you leave the baud page.

DEMO MODE

A demo mode is available, and can be activated in the diagnostics advanced setup (DIAG) menu. Four modes are available:

- **Mode 1;** is a **dynamic demo mode** taking the present value as the start point and slowly varying all the available values.
- **Mode 2;** is a **static demo mode** taking the present values and keeping them active.
- **Mode 3;** is a **fixed speed mode** with longitudinal 5 kn.
- **Mode 4;** is a user selectable **acoustic fixed speed mode**. The user selects the required speed and uses SET to activate/deactivate the signal. The system generates an acoustic signal equivalent to the required speed, and then measures it allowing the complete system to be checked.

When the demo modes are active, the sensor signal is ignored, and the screen will indicate the demo state with a blinking S in the upper right corner of the screen. The user can turn off the demo mode from the demo screen by pressing down (↓) button until OFF is shown on the screen, or the demo mode will turn off automatically after 10 hours.

MENU DIAGRAM

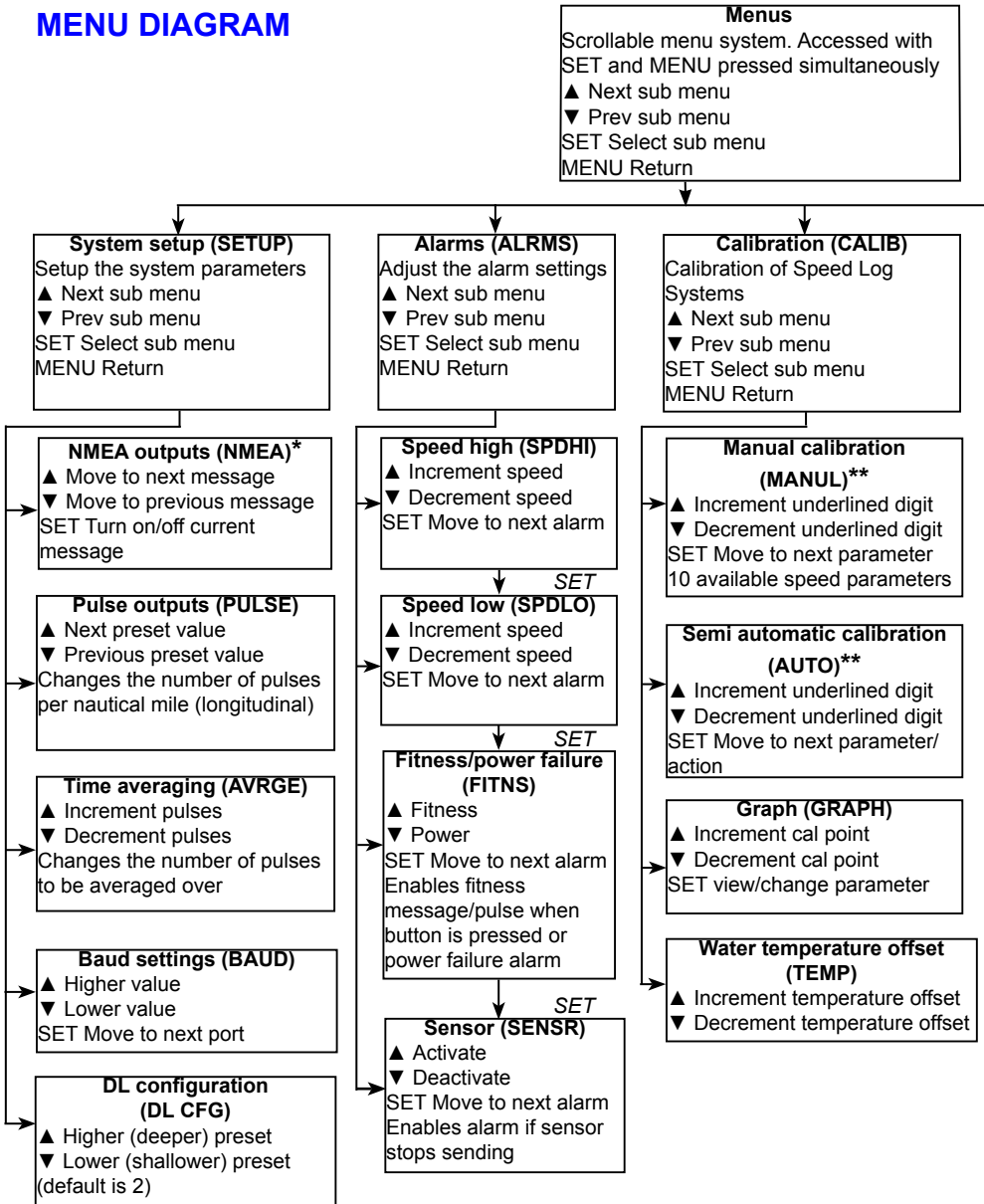

* One option in the NMEA settings is DIAG. This turns on some of the diagnostics outputs. These are proprietary messages that occur if an error occurs or if requested. Setting this to 'ON' will stop all other messages.

** Offset calibration not available in single axis system.

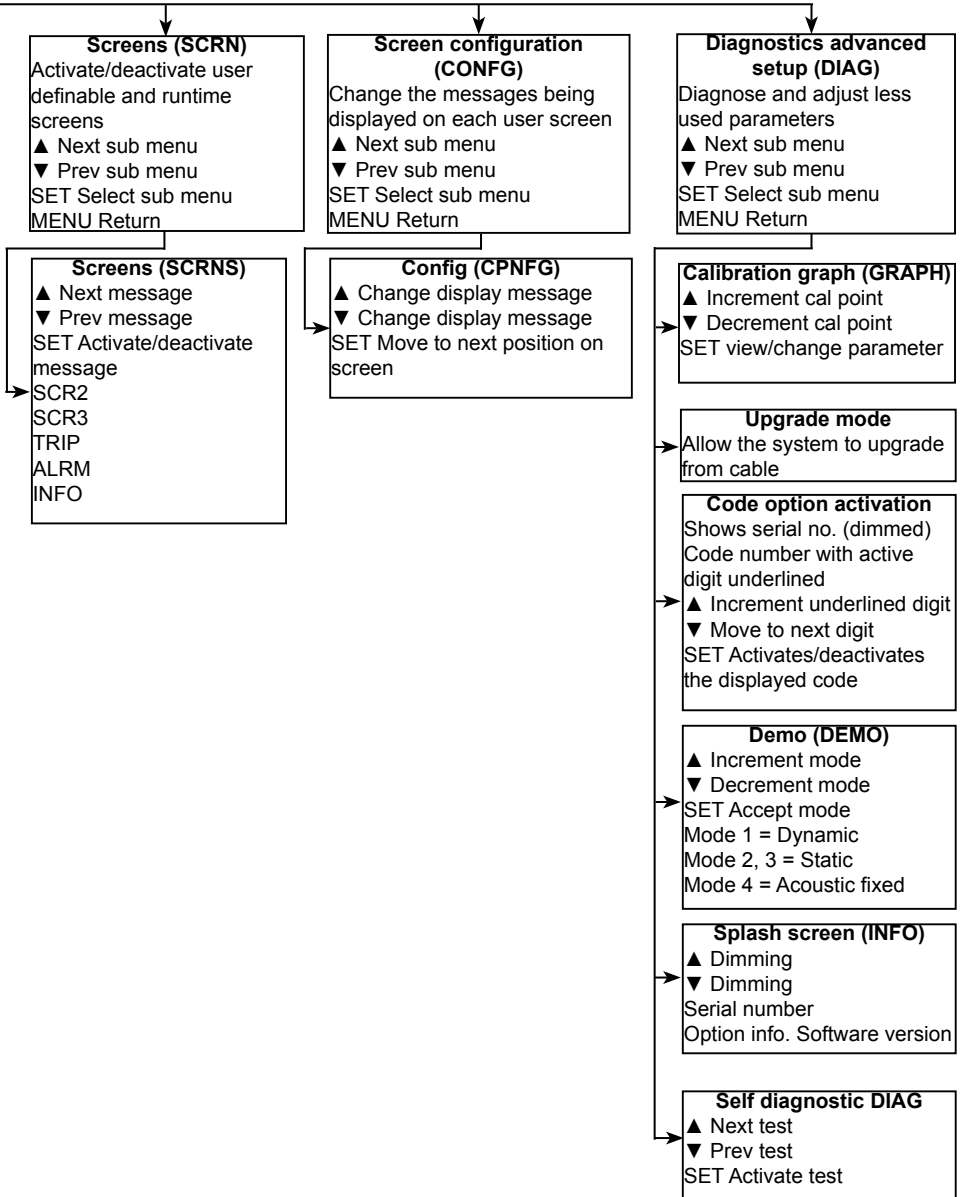

SETUP USING THE LAN WEB INTERFACE

Both JB70D1-XX and CD401CU-SC contain web sites for setup. To access these, the user must connect using a LAN cable (RJ45/CAT5) to the LAN port of the item to be set up (alternatively to the network they are connected to) and go to web page (Default 239.192.1.1XX for the JB70D1, or 239.192.2.1XX for the CD401CU-SC where XX is the last 2 digits of the serial number) or as marked..

Once connected to the correct equipment, it can be set up as follows:

The CD401CU-SC will be operating in a dumb terminal mode, and needs no setup.

The JB70D1-XX web site presents all the options as drop down boxes, and the user can setup all the parameters as desired.

Runtime menus

In this menu each of the three setup screens can be defined. Each line can be defined, however only parameters that fit together should be shown, and only with a relevant title above.



SKIPPER JB70D1-XX
Electronic unit for DL1

Home | System Configuration | (CD401CU) Configuration | Calibration / Alarms | Diagnostics / Maintenance | Help

Brightness:

Brightness is controlled by pulse into the CD401CU unit, by NMEA DDC message or through this web function.

Brightness level:
Brightness levels below 2 are not saved

Screen configuration:

	Screen 1:	Screen 2:	Screen 2:	Trip:	Alarms:	Info screens:
Operation:	<input checked="" type="radio"/> Enable <input type="radio"/> Disable	<input checked="" type="radio"/> Enable <input type="radio"/> Disable	<input checked="" type="radio"/> Enable <input type="radio"/> Disable	<input checked="" type="radio"/> Enable <input type="radio"/> Disable	<input checked="" type="radio"/> Enable <input type="radio"/> Disable	<input type="radio"/> Enable <input checked="" type="radio"/> Disable
Line 1:	TXT	TXT	TXT		Speed high	SKIPPER
Line 2:	STWLS	WTRSP	STWLS	TRIP	Speed low	System type
Line 3:	TXT	TXT	TXT	TRIPW	Fitness	CD On
Line 4:	TXT	10 L/W	10 L/W		Sensor	Fit ver. 01.20 F

Choosing TXT will either present the title of the parameter below or present a blank area.
 Only valid configurations are allowed.

The system has some intelligence in this choice, but the user should be careful that the display shows clearly what information is being shown.

System Configuration

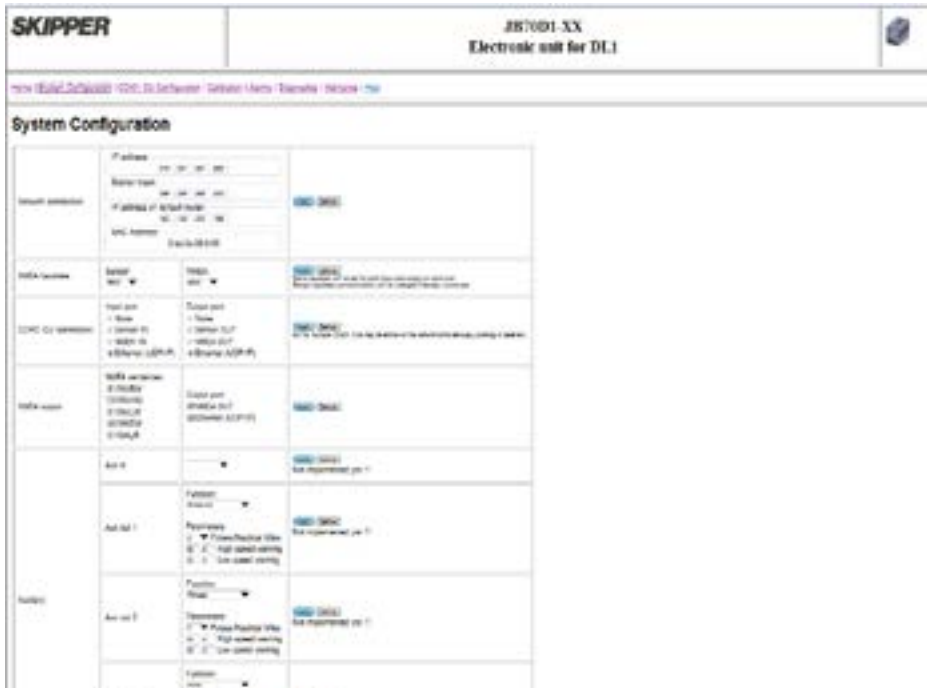

This setup screen allows the user to define the IP address of the unit. The range of allowed addresses is limited by standard IEC 61162-450.

The second section allows the user to activate the digital outputs, define the NMEA output parameters and activate/deactivate NMEA messages and also to define the usage of the auxiliary output.

The user can also adjust the averaging of the sensor.

- Higher average, more stable data, but slower in response (large vessels).
- Lower average, more jumpy data, but fast in response (small vessels).

SKIPPER Service software

SKIPPER has produced a free software (www.skipper.no) allowing a user/service technician to perform diagnostics over the network. This software will help to diagnose and setup the system. More details are available in the installation manual.

CHAPTER 5

CHECKING OUT YOUR SYSTEM

If you suspect something may be wrong with your DL1-Multi system, the system has possibilities to perform self diagnostics. This is available in the diagnostics menu. In addition, an up to date diagnostics guide can be downloaded from the support pages of www.skipper.no. The system is robust to most conditions, however high sea state or bubbles in front of the sensor may temporarily cause lower data quality. The system by default measures the speed through the water from depth 0.25 m to 3 m. If the water is shallower than 3 m, an element of the bottom speed may influence the results. This may be improved by changing the settings to position 1. Water temperature will have an effect on the speed accuracy; however the system uses the internal sensor to compensate for these changes.

SELF DIAGNOSTICS

The Compact Speed Log contains some diagnostic features to enable the user to decide which part of the system is failing. The last 20 errors are stored in the system and can be downloaded using the diagnostics port. If the error is serious, the system will cause a general alarm (if activated), and restart itself. Error numbers can be found in Appendix 5.

Test No.	What it does	What is wrong?
0	All LEDs dimming SET = on/off	Check for LEDs not working. Check normal screens for rows or LEDs sticking
1	Check internal memory.	If fail, the system is not able to communicate with the internal flash memory.
2	Send out a command to sensor and wait for response or same message back.	If fail, either the output or the input to the sensor is not working or the sensor is failing.
3	Write out 80 characters to NMEA, ask user to press if ok, or read back.	Manually check the output. If fail, try to restart.
4	Write out 80 characters to SENSOR, ask user to press if ok, or read back.	Manually check the output. If fail, try to restart.

Test No.	What it does	What is wrong?
5 - loop	Turn on alarm - wait for reset or loopback.	The user or loopback should reply to the alarm by pressing the alarm reset, (works only in test configuration).
6 - loop	Pulse out sends a pulse. If looped back to dimming up, this test will pass.	Fail implies the pulse out or dimming up is not working. Try individually, (works only in test configuration).
7 - loop	Fitness out sends a pulse if looped to dimming down this test will pass.	Fail implies the fitness out or dimming up is not working. Try individually, (works only in test configuration).
8 - loop	Test NMEA Baud 4800, 38400, 115200 (only passes if looped to the input).	Fail implies one of the speeds is not working correctly, (works only in test configuration).
9 - loop	Test Sensor Baud 4800, 38400, 115200 (only passes if looped to the input).	Fail implies one of the speeds is not working correctly.
10	Status of transducers (Doppler only)	The screen will show the 2 speed values recieved by the sensor, and a quality value. If the values are similar in + and -, and quality over 2, the test passes. This test may occasionally fail, as objects pass the vessel, but should pass most of the time.

Tests 5 - 9 are designed to be smart by sending and receiving information at the same time. They require loopback or the user to enter the expected reply. These tests are primarily for factory use, but a loop plug can be made as described in the installation manual.

In addition, the system as a whole can be tested using the DEMO mode 4.

The screenshot shows the 'Diagnostics' page of the SKIPPER JB70D1-XX web interface. At the top, there is a navigation bar with the SKIPPER logo on the left and the product name 'JB70D1-XX Electronic unit for DL1' on the right. Below the navigation bar, there are several menu items: Home, System Configuration, CD/D1 Config, Calibration, Alerts, Diagnostics (highlighted), and Help. The main content area is titled 'Diagnostics' and contains two sections. The first section, labeled 'Software', has a dropdown menu set to 'Turn on all LOG emergency display' and a 'Description of Software' link. The second section, labeled 'Demo', has a dropdown menu set to 'Mode: 0 Off' and a 'Description of Demo mode' link. There are also buttons for 'Start Demo' and 'Cancel'.

If a fault is suspected, diagnostics and in built test (BIT) can be used to check all elements of the system. Tests are selected from a drop down list, and a description of the tests can be viewed by clicking on the hyperlink below the dropdown box. Tests will check hardware, communications and the acoustics of the sensor.

In addition, a demo may be started to give simulated values out of the interfaces and on screen. In this case a 'S' will flash on screen. A special acoustic simulator is available for the DL1 sensor, that sends acoustic signal out and measures the return to check the whole system.

The screenshot shows the 'Maintenance' page of the SKIPPER JB70D1-XX web interface. At the top, there is a navigation bar with the SKIPPER logo on the left and the product name 'JB70D1-XX Electronic unit for DL1' on the right. Below the navigation bar, there are several menu items: Home, System Configuration, CD/D1 Config, Calibration, Alerts, Diagnostics, and Maintenance (highlighted). The main content area is titled 'Maintenance' and contains a table with two rows. The first row is for 'System type' and shows 'Current System type: CD/D1', 'Serial number: SN CD999999', and 'Code: 0408'. The second row is for 'System IP/1 NAME' and shows '(Maximum 20 characters)'. Both rows have 'Apply' and 'Cancel' buttons.

The maintenance page allows you to check the software version of the system. It is not possible to directly upgrade from this page, however a separate uploader application is available from the web pages.

TEST POINTS WITHIN THE SYSTEM

In addition to the internal system testing, it is also possible to connect a PC with a COM port to the 9 pin RS-232 "COMPACT" DSUB in the JB60CD unit box. By using hyperterminal, or the SKIPPER service software, many additional features can be checked.

It is also possible to see what is happening within the system by observing the LEDs inside the JB70D1-XX electronic unit (see diagram "[Status LED diagram](#)" [on page 33](#)).

Here you can check if the sensor is operational.

On Diagram	LED	Colour	Description
11	NMEA in		Flashes each time data is received.
2	NMEA out		Flashes each time data is sent.
3	Pulse out		Flashes each time pulse is sent.
12	Sensor in	Red	Flickers with data being sent from the sensor (not so common).
8	LAN power	Green	+24 V supplied via the LAN cable for direct connection to CD401CU. This will not damage routers or other devices, but does not follow full PoE standard.
7	LAN data	Yellow	Flashes with each NMEA out transmission to navigation system.
1 or 9	STATUS 1 or STAT	Red	Flashing = status ok. Constant = Power but CPU not operating
5,6	24 V		Active.
4	AC		Active.

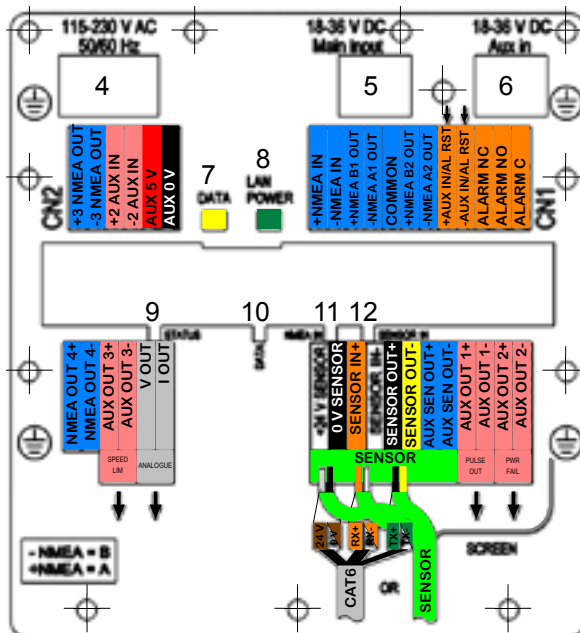

STATUS LED DIAGRAM

CHAPTER 6

MAINTENANCE

ROUTINE MAINTENANCE

Very little maintenance is required for the system.

Each service

- Check software version and update.
- Run built in diagnostics.

Docking

- Lift the sensor to check valve function (if fitted).
- Grease movable parts.
- Check for damage or corrosion on the connection box.
- Carefully clean and scrape the front face on the sensor, if required.

We do not recommend painting the face of the sensor.

Advised spare parts

There are no necessary spare parts, fuses are automatic and will reset when a problem condition is removed. Parts most likely to fail are sensor (DL1SXX-XX or processor card PI-M001 see ["1\) Exploded view" on page 38](#)).

CHECKING YOUR VERSION

If the info screen is activated on the run screens, the system type and software version can be read from there. Otherwise the same screen can be obtained in the diagnostics/info menu. The system type will be one of the following:

CD E1	EML 124 compact display 1 axis
CD E2	EML 224 compact display 2 axis
CD EB	EML 124/224 compact display "reversible" mode
CD LR	Log repeater compact display
CD MR	Multi repeater compact display
CD MB	Multi repeater compact display "backwards" mode
CD D1	Doppler compact display 1 axis (retro version)
CD CU	CD401 control unit (all control in JB70D1) - In this mode the system is system independant and control comes from the setup of the JB70D1-XX electronic unit (available on the web interface)

The system will be locked to one of these setups, but can be changed to one of the other systems (with an additional cost) using a code.

SOFTWARE UPGRADE

The system is undergoing continuously improvement, and periodically new software will be released. These can be found in the download area of the SKIPPER website (www.skipper.no) and may be downloaded and the system upgraded using the LAN port of the electronic unit (JB70D1-XX).

To upgrade the software, /connect a laptop/PC to the LAN port and the item to be upgraded. Open the SKIPPER Service software (downloadable from www.skipper.no). Select the unit to be upgraded and follow the instructions on screen. The sensor is automatically upgraded from the JB70D1 unit.

MASTER RESET (FACTORY DEFAULT SETTINGS)

The factory default settings can be restored by performing the following operations:

1. Select CODE in diagnostic (DIAG) menu.
2. Press the SET button (**Note:** Do not change code value, just press the SET button.)

The unit will now restart with factory default settings.

Note. This will also **reset** the stored calibration values.

SKIPPER DL1-Multi

Single Axis Doppler Speed Log

Speed Log

Single Axis

Compact Display

Automated

Accurate Readings

Water Temp



The SKIPPER DL1 is a single axis speed log, working on the Doppler principle, providing longitudinal ship's speed and distance relative to sea water. The SKIPPER DL1 gives accurate navigation parameters, measured as they happen, and presented in a logical, user friendly way.

SKIPPER Electronics manufacture marine electronics for the merchant fleet as well as the fishing fleet, based on experience, research and tradition. Our products are known worldwide for reliability, sophistication and good value for money.

Features:

Speed through water in 1 axis

Water temperature

Interfaces - NMEA 0183

Display - 28 x 30 LED dot matrix with full night dimming

3 easy to use, user programmable displays, integrated menus

Fully automatic settings

Mounting options - Tank, Sea valve for single or double bottom hull designs



Web based configuration.

Doppler technology is considered as a good solution for speed log requirements.

The SKIPPER DL1 measures the speed of the vessel through the water at all times and in any depth. The system includes a single sensor mounted in a tank or sea valve. The display housing can be mounted anywhere on the bridge and a connection box can be placed wherever it is most convenient for connection. A LAN port within the connection box allows for easy installation and diagnostics from a laptop web page.

The JB70D1 is interface unit with extended connectivity, allowing the user to use yesterday's (pulse) outputs, today's (NMEA 0183), and tomorrow's (LAN) interfaces.

In addition to the compact display setup, A simple web based setup simplifies setup and calibration procedures. The onboard intelligence in each part of the system allows parts to be removed and replaced without reprogramming. OEM users can remove parts of the system and add their own items. But still get the advantages of the new system.

"Serve you further"

e-mail: sales@skipper.no

www.skipper.no

Navigation Speed Logs, Echo Sounders, Sonar and Direction Finders

SKIPPER DL1-Multi

Single Axis Doppler Speed Log

Specifications Overview

Log	SKIPPER DL1	Units
Number of Axis	1	
Speed range Long	±50	knots
Speed range Trans	na	knots
Water track (from)	2	m
Accuracy (better than)	0.2 or 2 % whichever is greater	knots
Speed resolution	0.1	
Temperature accuracy	Better than 1	°C
Temp resolution	0.1	
Display	28 x 30	LED's
Mounting dimensions	124 x 124 Bracket or panel mounting	mm
Front plate	144 x 144 to DIN standard	mm
Cabinet mounting depth with cable	90	mm
Weight cabinet	2.5	kg
Standard cable length for display	None - Pluggable (IP23)	
Standard cable length for sensor	40	m
Mounting		
Sea Valve:		
Single bottom	Yes	
Double bottom	Yes	
Tank:		
Steel	Yes	
Aluminium	Yes	
Retrofit available for Sagem, Simrad NL, Sperry, SAM and Atlas		
Speed alarms	High and low speed limits Power failure Sensor failure	
Outputs	- 4 x NMEA 0183 (IEC61162-1) - 3 x isolated outputs (pulse,power failure etc.). - Alarm (relay) -LAN (IEC61162-450)	
Inputs	- 1 NMEA 0183 (OPTO isolated) - External Dimming (pulse)	
Accepted NMEA formats	VTG, RMC, GGA, ACK	
Outputs		
Speed	VBW, VHW	
Distance	VLW	
Others	MTW (temp), ALR	
Power supply	AC: 115 - 230 V 50/60 Hz DC: 24 V	
Power consumption	Max. 30 W	
Certified for MED B (Wheelmark)	IEC61023, IEC60945, IEC61162-1/2/450, IEC62288, ready for IEC61924	
Language	English	

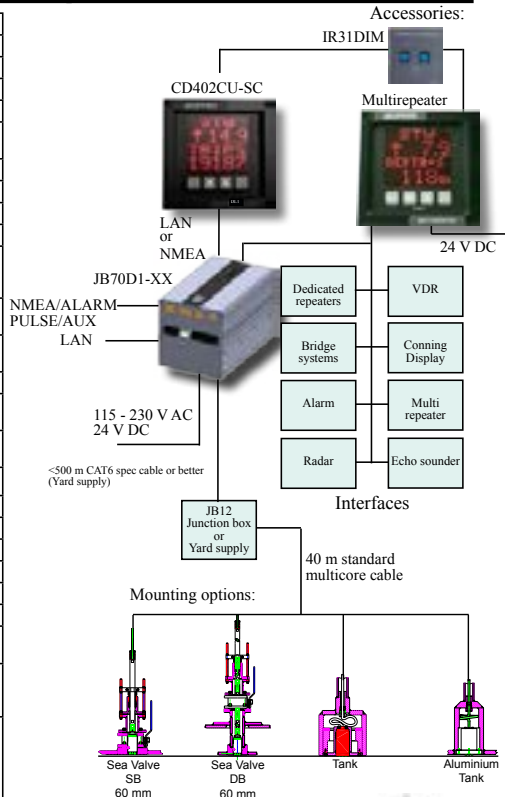

SKIPPER Electronics AS
 Enebakkveien 150
 P.O.Box 151, Manglerud
 0612 Oslo, Norway
 E-mail: sales@skipper.no
 Telephone: +47 23 30 22 70
 Telefax: +47 23 30 22 71
 Co.reg.no: NO-965378847 - MVA
www.skipper.no
 Date: June 2013
 Version: 20062013

SYSTEM SPECIFICATION

APPENDIX 1

BACKGROUND INFORMATION

Doppler

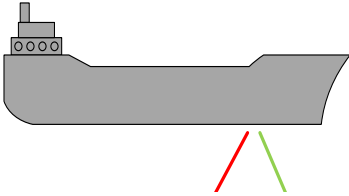

The Doppler system operates by sending a known frequency sound into the water, and listening to the reflected echo from the minute particles in the water. If the particles are moving towards the sensor, the frequency goes up, if away, the frequency goes down. By having two beams at 30 degrees from the vertical we get two frequency values, one plus, one minus, and these can be adjusted to show the speed of the vessel in the horizontal plane. As the amount of particles in the water can vary, the user can ensure the system has optimal signal return, by adjusting the power and length of the sample, depending on depth. The more sample time the better the signal, but the deeper the sampling

Calibration explained

Calibration is piecewise linear, i.e. a linear line is plotted from calibration point to calibration point (sorted by size) and this linearity is applied to the incoming values. This can be seen on the graph screen. The system uses these points as scaling factors for the speed. If the points are too close, a small error will be exaggerated. Points should be chosen at the outer speed limits of the system. and then speeds tried between. If these are not good enough, extra points can be added.

Calibration graph with focus on point 1

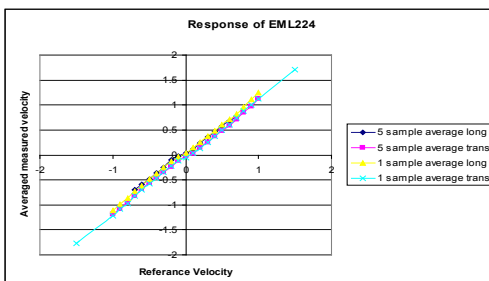

APPENDIX 2

MECHANICAL DRAWINGS

To help planning and installation, the following diagrams are supplied.

1. Exploded view
2. System overview diagram

In addition, further guides for mounting of your particular mounting can be found in the separate installation manual, supplied, or available at www.skipper.no

1) EXPLODED VIEW

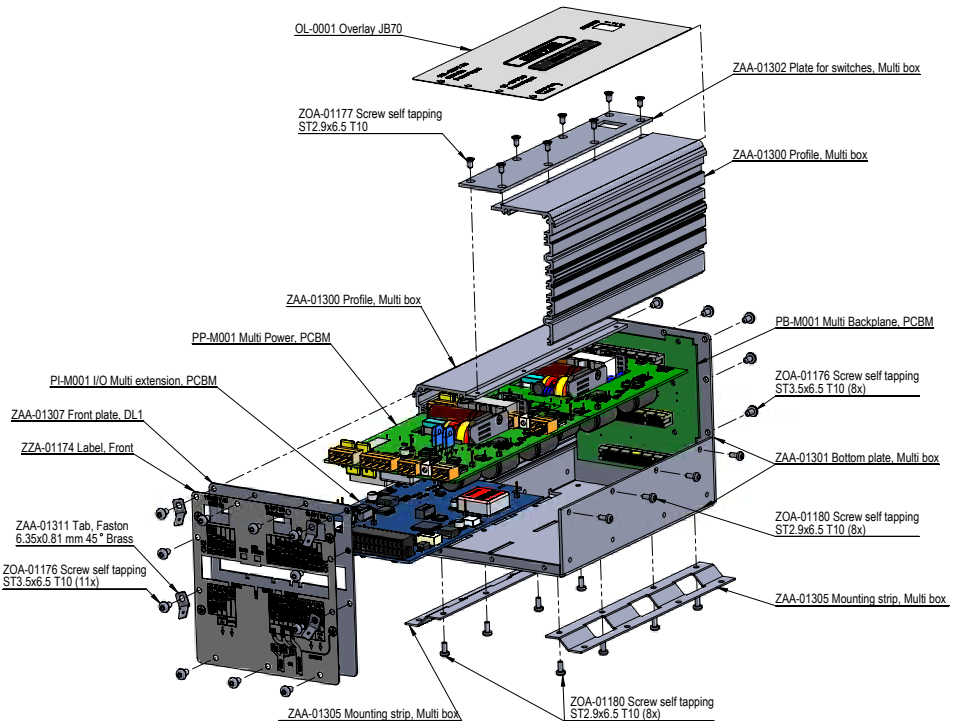

This page intentionally left blank

2) SYSTEM OVERVIEW DIAGRAM

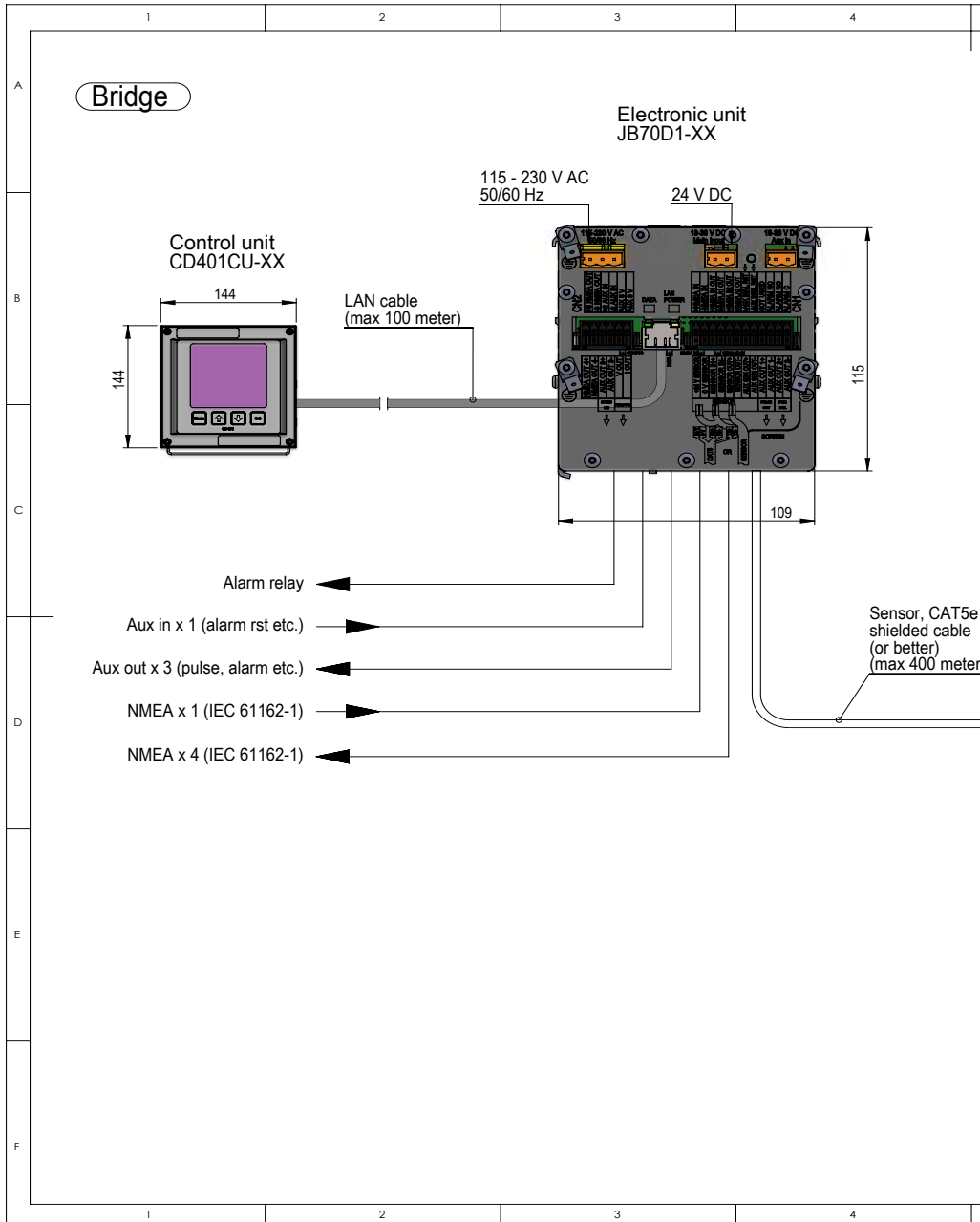

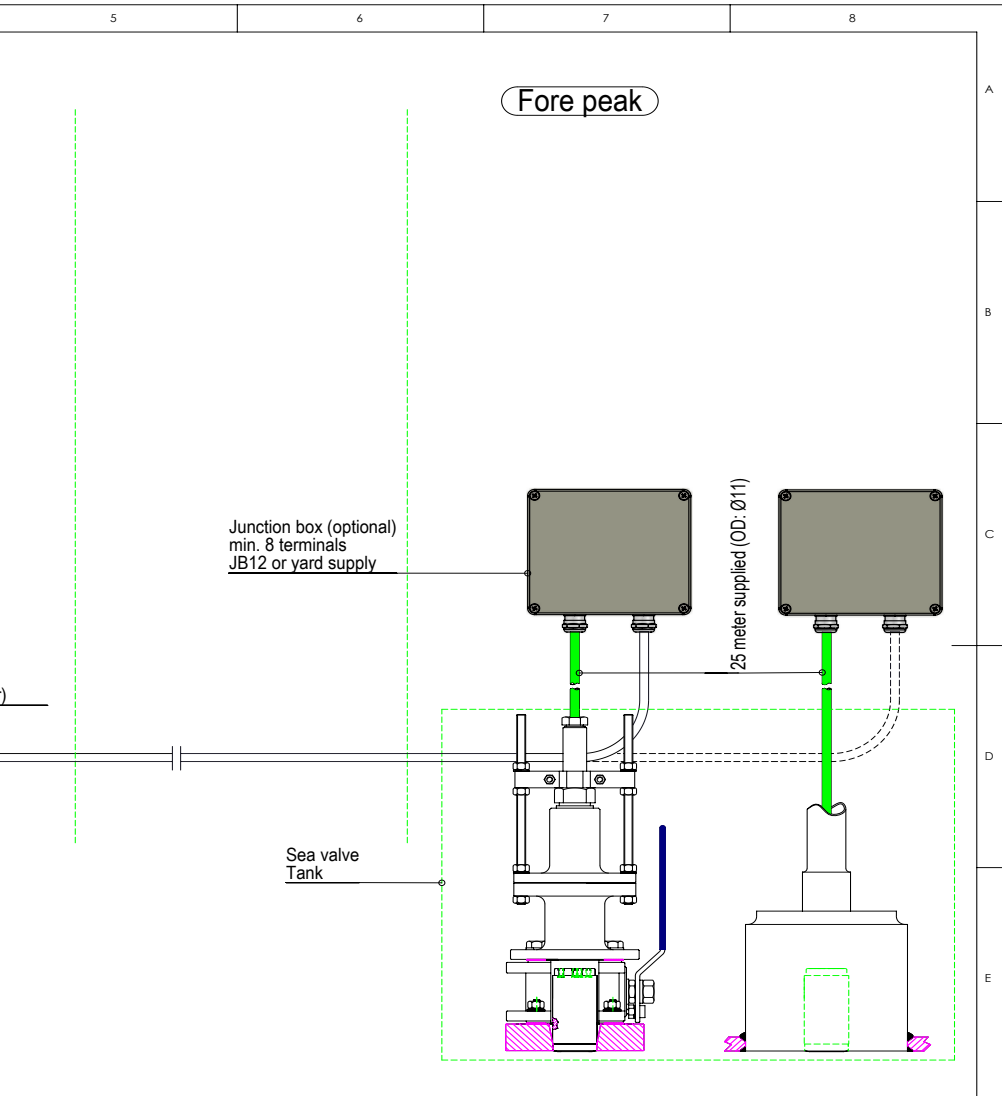

CN									
Designed by - date HK 2012.11.26	Checked by	Approved by - date	Material						
			Name DL1 System Drawing						
			Drwg. no. CD-2035						Revision X0
Gen. tolerance ISO2768m		Eur. projection			Scale 1:5	Edition date		Sheet 1 of 1	

APPENDIX 3

SENDING THE SYSTEM FOR REPAIR

In the chance that a system fails, it may be necessary to send a part of the system back for repair. Make contact with your local dealer or SKIPPER for Returns Materials Authorisation number (RMA). (A list of service centres is available on www.skipper.no)

For normal service/support, please contact SKIPPER Electronics AS on e-mail: support@skipper.no, or contact your local dealer (list available on www.skipper.no).

WARRANTY AND UTILIZATION

Warranty

- SKIPPER Electronics AS gives 12 months limited guarantee on all deliveries from SKIPPER Electronics AS, Norway.
- Please note that if the equipment is delivered by a third party, the third party warranty conditions may apply.
- All warranty request should be sent to the local supplier of the equipment.

Utilization

- This equipment is not to be disposed in normal waste, but be handled in accordance with applicable waste disposal regulations in the country where the equipment is used.

INSTALLATION/COMMISSIONING OF THE EML224 COMPACT

Boat/build name		Date:		Bridge manufacturer:			
Equipment summary:							
Display:	CD401CU -		Serial no.:				
Electronic unit	JB70D1 -		D1/EML	Serial no.:			
Cable type:			Length:				
Sensor:	EML 224	DL1	Sea valve	Tank	Serial no.:		
Bottom part:	Tank type		Valve type		Serial no.:		
Equipment Details:							
Bottom part:	Bolts checked		Alignment correct		Sensor fully inserted		
Electronic unit:	Mounted where?			NMEA out going to?			
	Pulse connected to?			LAN connected to?			
	Power connected		24 V	115 V	230 V		
Alarms	System alarm to?		NO ALR	NC	Power Fitness alarm to?		
Display	Cable type			NMEA outputs	VBW	VLW	VHW MTW
Calibration Data:							
Speed calibration							
Point ____ (low speed)		Real:		Measured:			
Point ____ (high speed)		Real:		Measured:			
Point ____		Real:		Measured:			
Commisioned by:			Company:			Email:	

SKIPPER

SKIPPER Electronics AS
Enebakkeveien 150
P. O. Box 151, Manglerud
0612 Oslo, Norway
www.skipper.no

Telephone: +47 23 30 22 70
Telefax: +47 23 30 22 71
E-mail: support@skipper.no
Co. reg. no: NO-965378847-MVA